

3 Drawer Dresser

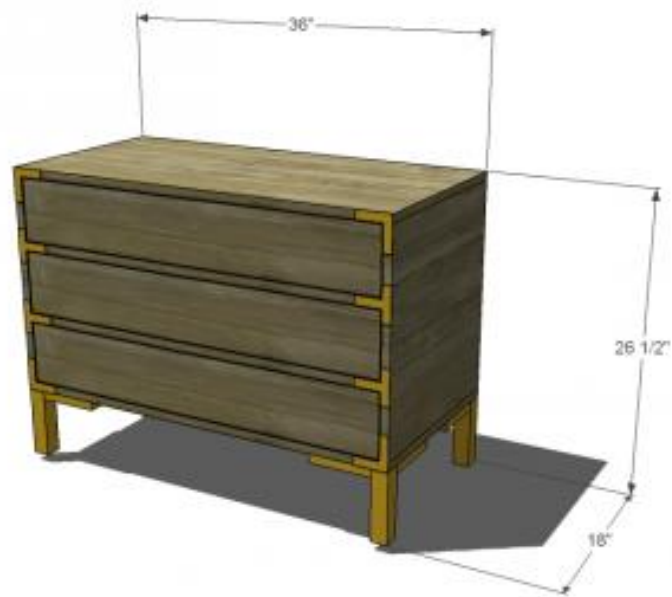

Materials:

- (1) 2×2 at 3'
- (2) 1×2 at 8'
- (3) 1×6 at 6'
- (1) 1×6 at 8'
- (1) 4' x 8" x 3/4" plywood
- 1 1/4" pocket hole screws
- 1 1/4" screws
- 3 drawer pulls
- (3) sets of 16" drawer slides
- (4) 3" x 3" Flat Angle Plates
- (4) 3" x 3" Flat T Plates

Cut List:

- (4) 2x2 at 6-1/4" – Legs
- (8) 1x2 at 5-1/2" – Leg Braces
- (2) 3/4" plywood at 18" x 36" – Top & Bottom
- (2) 3/4" plywood at 18" x 18-3/4" - Sides
- (1) 3/4" plywood at 18-3/4" x 34-1/2" - Back
- (2) 1x2 at 34-1/2" – Stretchers
- (3) 3/4" plywood at 14-1/2" x 32" – Drawer Bottoms
- (6) 1x6 at 14-1/2" – Drawer Sides
- (6) 1x6 at 33-1/2" – Drawer Front & Back
- (3) 3/4" plywood at 5-1/2" x 34-1/4" – Drawer Fronts

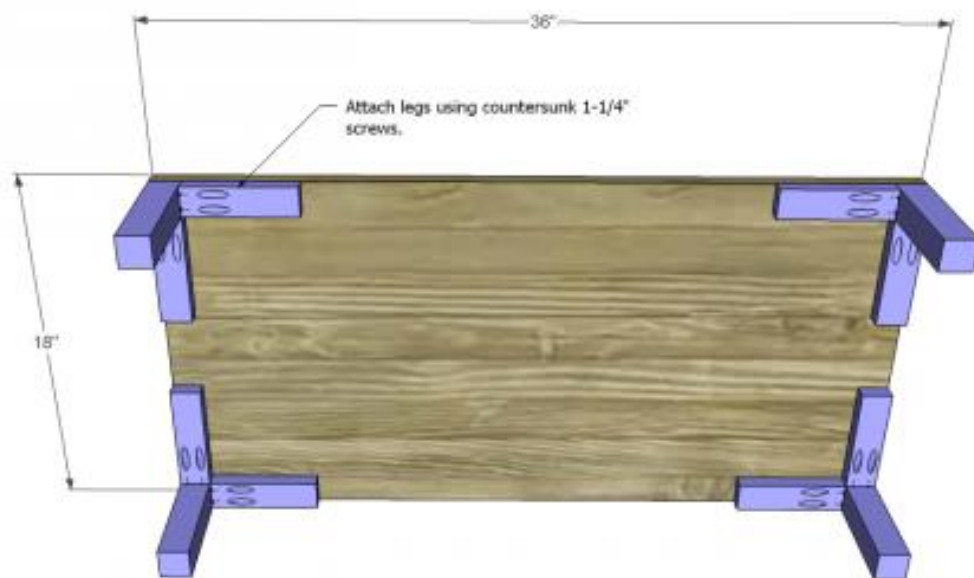
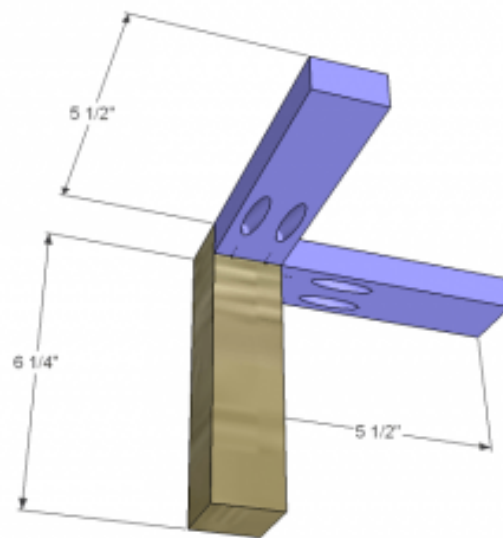

Edge banding will be applied to the exposed edges of the plywood before assembly. Cut the pieces for the legs and the leg braces. Set the Kreg jig for $\frac{3}{4}$ " material and drill pocket holes in one end of each of the leg braces. Attach to the leg using glue and 1- $\frac{1}{4}$ " pocket hole screws. Cut the piece for the bottom. Attach the legs to each corner using glue and countersunk 1- $\frac{1}{4}$ " screws.

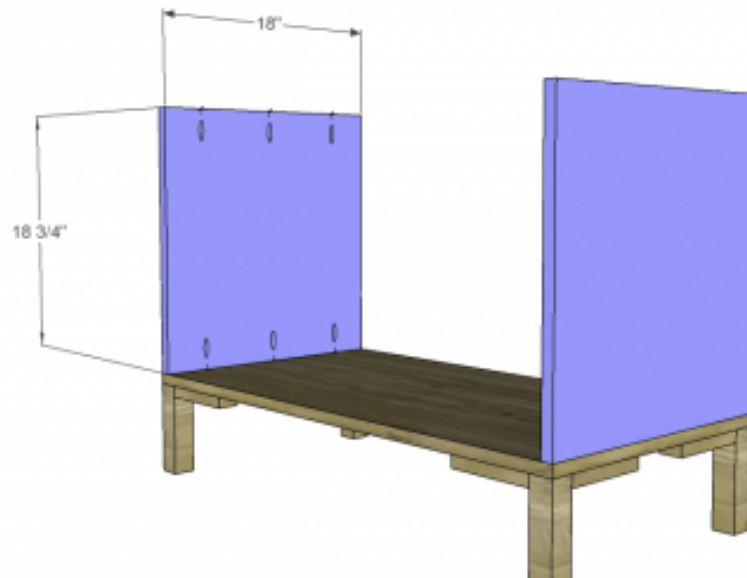

Cut the pieces for the sides and drill pocket holes in each end. Attach to the bottom using glue and 1- $\frac{1}{4}$ " pocket hole screws.

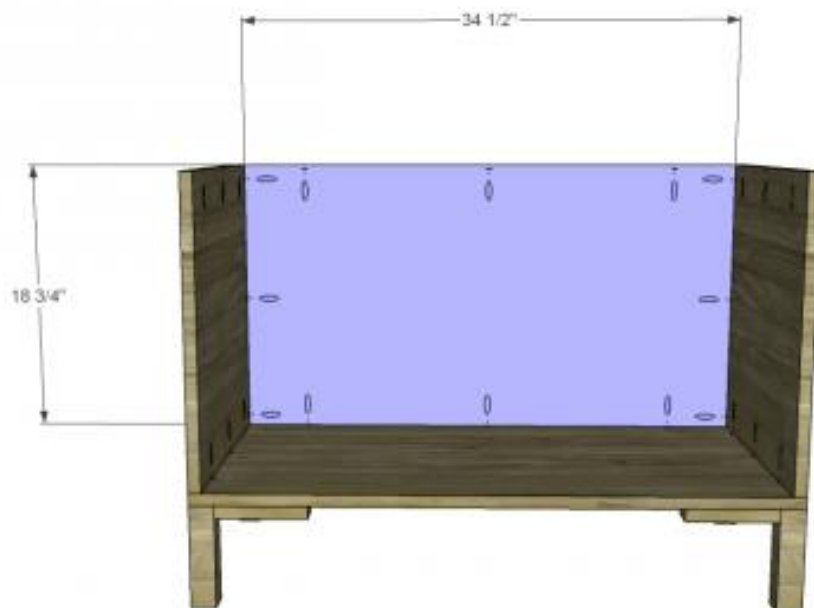

Cut the piece for the back and drill pocket holes in all four edges. Secure to the sides and back using glue and 1- $\frac{1}{4}$ " pocket hole screws.



Cut the piece for the top. Secure with glue and 1-1/4" pocket hole screws through the sides and back.

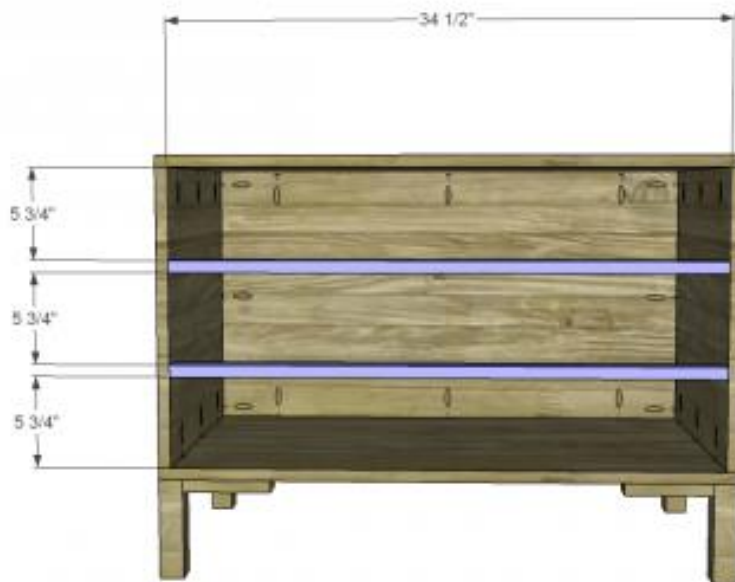

Cut the pieces for the stretchers and drill pocket holes at each end. Position as shown then secure using glue and 1-1/4" pocket hole screws.

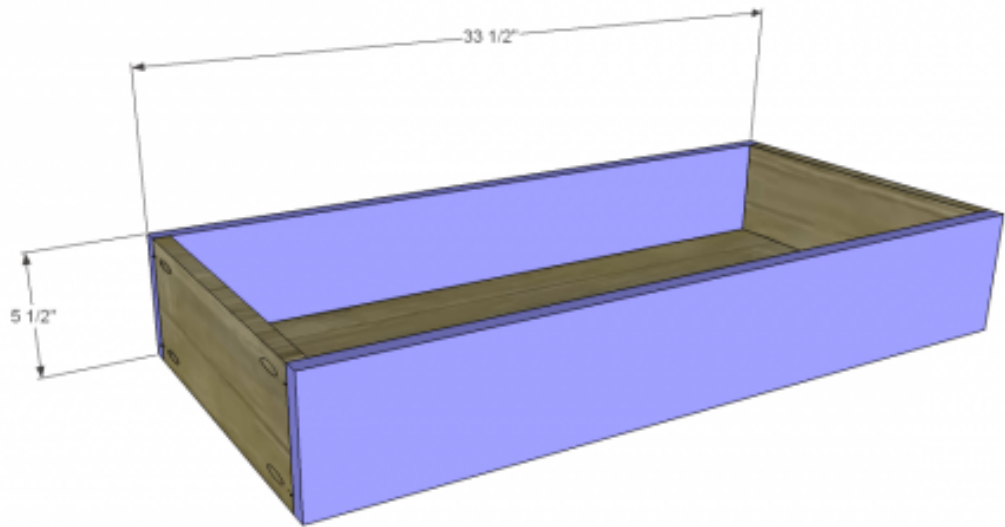
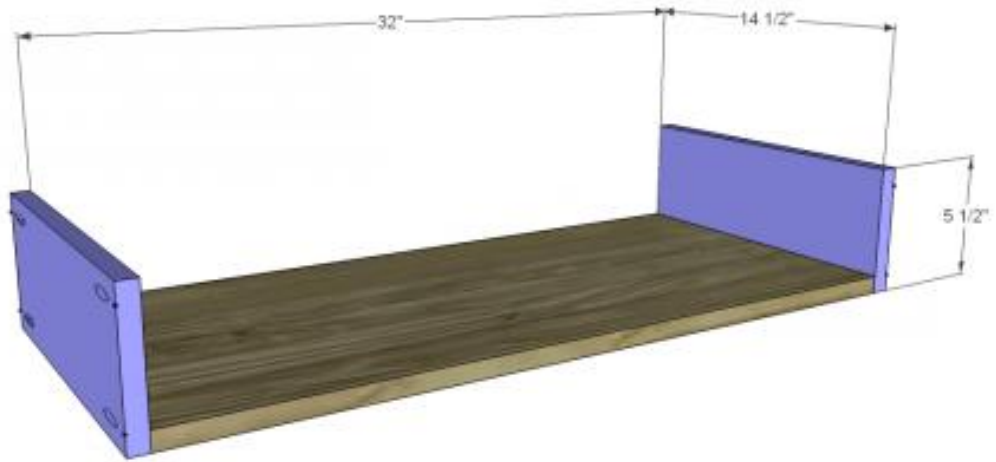

Cut the pieces for the drawer boxes. Drill pocket holes in each end of the sides as well as all four edges of the bottoms. Assemble the drawers as shown using glue and 1-1/4" pocket hole screws. Install the drawer slides according to the manufacturer's installation instructions. Make any necessary adjustments.

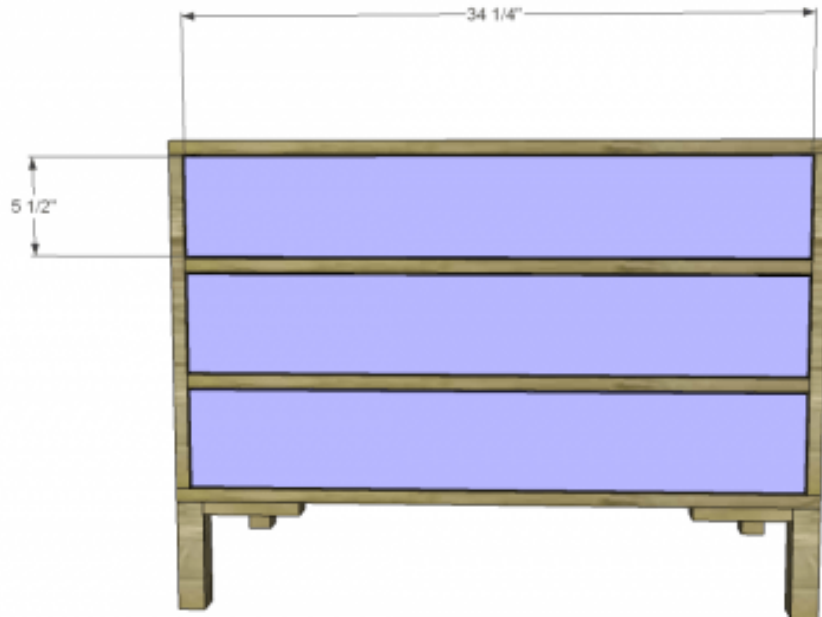

Cut the pieces for the drawer fronts. Mark the position for the drawer pulls and drill the holes. Install the drawer box, then shim the drawer front in place. Finish drilling the holes for the drawer pulls, then install. Paint the angle and bracket hardware as desired, then install.

Fill any Screw, Nail or Pocket Holes, Sand and Finish as Desired.